

PAX1800

Dual-band Access Point
 WiFi 6 / 802.11ax
 100% outdoor ready
 Cloud managed



PAX1800



2.4 GHz 802.11ax and 5 GHz 802.11ax concurrent WiFi



Zero Config Plug-n-Play



Free cloud-based web console for complete management



Water and dust resistant with an IP55 rating



Universal installation kit included

DUAL-BAND WiFi 6 / 11AX ACCESS POINT

Plasma Cloud's WiFi 6 universal solution for almost any setup. With dual band & dual stream 802.11ax WiFi in a compact weather resistant housing the PAX1800 may serve as office or hotel WiFi backbone, coffee shop hotspot and outdoor WiFi extension. It shines in high density and high throughput demand scenarios as well, such as in schools, universities, airport and shopping malls.

POWER OVER ETHERNET (PoE)

Power over Ethernet (PoE) allows to supply a device with power and data over a single Ethernet cable connection. This reduces installation cost and effort for locations without available power lines. Furthermore, when connected to a Plasma Cloud PoE switch, PoE allows to centrally manage & monitor the power supply.

ETHERNET PORTS

The 2 provided Ethernet ports allow for maximum flexibility: one port can be used as wired uplink while the other port serves as LAN access for other wired devices. Each Ethernet port comes with a smart uplink detection to automatically determining whether a port should be uplink or provide LAN access.

MOUNTING OPTIONS

Regardless where to place the access points – on a wall, ceiling grid, pole, outdoors – the installer kit included with every AccessPoint facilitates the installation. Easily pluggable mounting options got you covered for every scenario.

NETWORK AS A SERVICE (NaaS)

HIGHLIGHTS:

- Access Control
- Presence Data
- Guest WiFi
- Advertising
- Proximity Marketing
- VPN

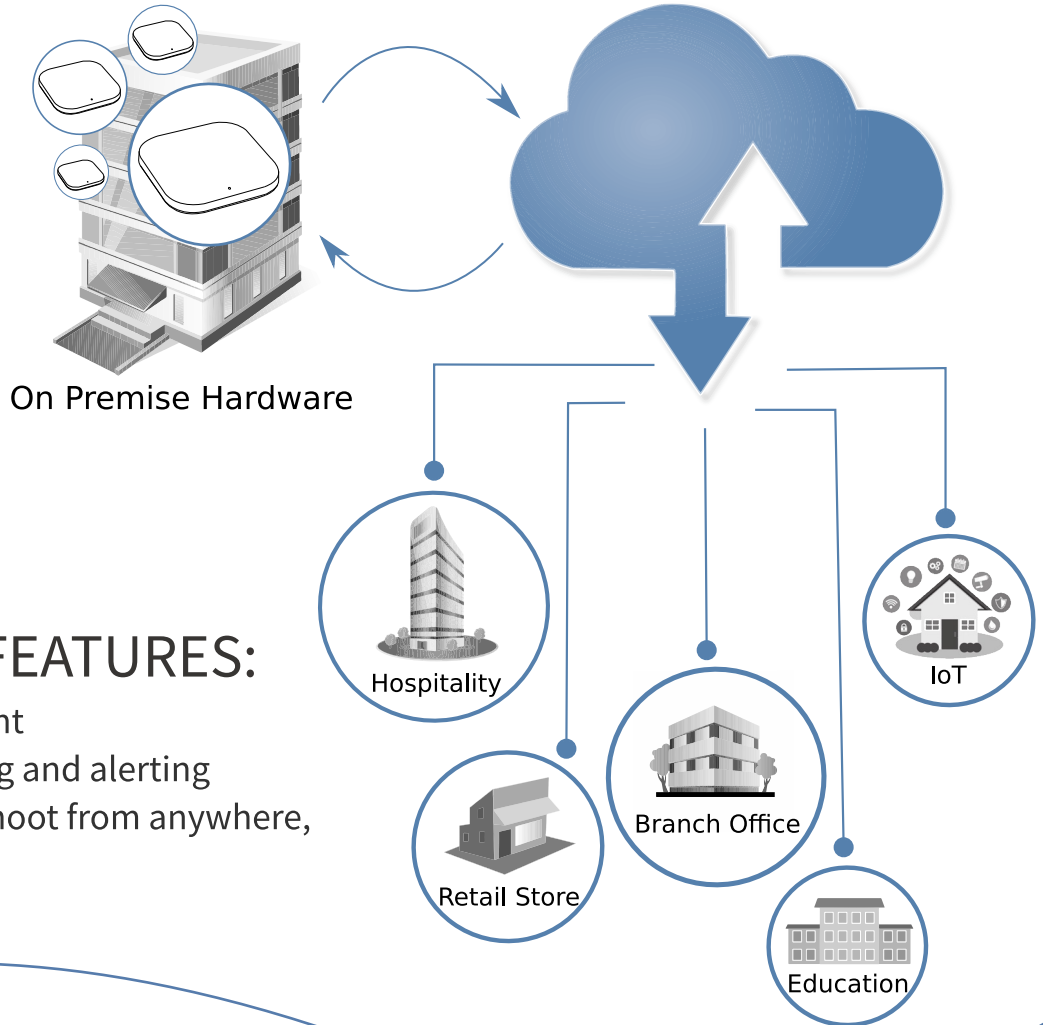

CLOUD KEY FEATURES:

- Zero touch deployment
- Automated monitoring and alerting
- Manage and troubleshoot from anywhere, anytime

INDUSTRY LEADING SOFTWARE AND PRODUCTS



Affordable Network Solution

Plasma Cloud offers an affordable turnkey solution to cover all needs in and around your network. WiFi Access Points and Switches in various sizes to fit your needs & budget bundled with free & powerful cloud management.



Best In-Class Cloud

Plasma Cloud's technology team has built the fastest and most scalable network management cloud system. Our experts have put in their combined experience to develop a truly unique product that will impress you in many ways.



Simplicity is Key

Plasma Cloud is designed for the needs of those tired of endless manual tweaking and cumbersome monitoring. Our smart software is designed to minimize setup effort to the essential and get you started in no time!



White-Label Dashboard

Our dashboard is the reference web interface. It is designed to be highly customizable, both for branding and adaptation purposes as well as for the end-user.

HOUSING

- IP55 Certified Outdoor Housing
- Water Resistance

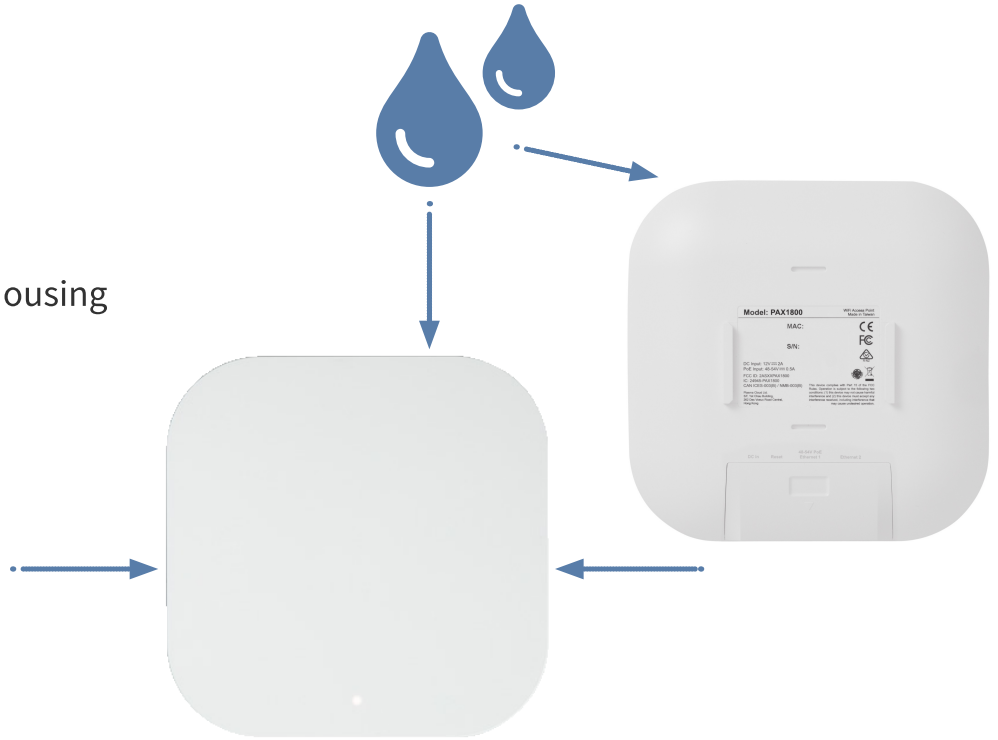

 Operating temperature: 0 °C ~ 40 °C

 Operating humidity: 0% ~ 90% typical

 Storage temperature: -30 °C ~ 80 °C

Water resistant design with sealed top and bottom enclosures and water resistant cable bay allows versatile installation environment including shaded garden, under eaves, outdoor shed, or veranda.

MOUNTING OPTIONS

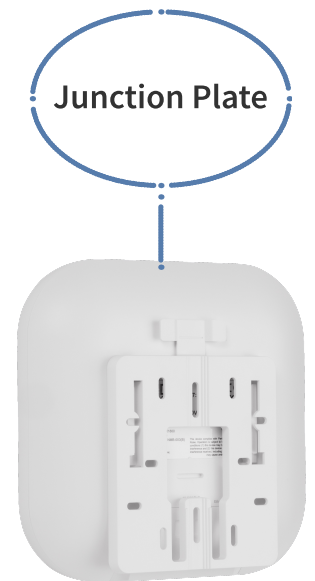
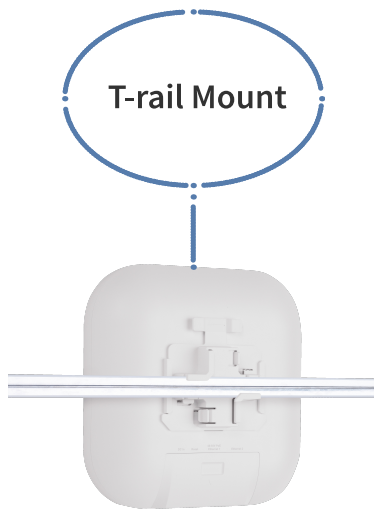

TECHNICAL SPECIFICATIONS

Radio Chains / Streams	2.4 GHz : 2x2 5 GHz : 2x2
Antennas	2.4 GHz : 5.0 dBi 5 GHz : 5.0 dBi
Data Rates	573 Mbps + 1201 Mbps
2.4 GHz	2 stream, 802.11 b/g/n/ax (max rate: 574 Mbps), MU-MIMO/OFDMA
5 GHz	2 stream, 802.11 a/n/ac/ax (max rate: 1201 Mbps), MU-MIMO/OFDMA
Processor	Qualcomm Cypress IPQ6000
Memory	512 MB DRAM DDR3 64 MB NOR Flash
Watchdog Timer	Microchip PIC10F200T-I/OT
Physical Interface	2x 1000 Mbps Ethernet ports
PoE	802.3at
DC Jack	12V / 2A
Power Consumption	Min : 5W (PoE) / 3.5W (DC) Max : 13W
Indoor / Outdoor Rating	CE marked for indoor / outdoor use, IP55
Dimension (W x D x H)	180 x 180 x 37 mm
Weight	500 g
Operating Temperature	0 °C ~ 40 °C (32 °F ~ 104 °F)
Certifications	CE, FCC, IC, RCM
Zero Config Plug-n-Play	Yes
Wireless Mesh Network	Yes
Free Cloud Console	Yes
Free Mobile App	Yes

RADIO 1, 2.4 GHz:

RF PERFORMANCE TABLE

Operating Mode	Data Rate	TX Power	RX Sensitivity
802.11b	1 Mbps	23 dBm	-94 dBm
	2 Mbps	23 dBm	
	5.5 Mbps	23 dBm	
	11 Mbps	23 dBm	-88 dBm
802.11g	6 Mbps	23 dBm	-91 dBm
	9 Mbps	23 dBm	
	12 Mbps	23 dBm	
	18 Mbps	22 dBm	
	24 Mbps	22 dBm	
	36 Mbps	22 dBm	
	48 Mbps	21 dBm	
	54 Mbps	21 dBm	-72 dBm
802.11n (HT20)	MCS0	23 dBm	-91 dBm
	MCS1	23 dBm	
	MCS2	22 dBm	
	MCS3	22 dBm	
	MCS4	21 dBm	
	MCS5	21 dBm	
	MCS6	20 dBm	
	MCS7	20 dBm	-72 dBm
802.11ac (VHT20)	MCS8	19 dBm	-68 dBm
	MCS9	19 dBm	-66 dBm
802.11ax (HE20)	MCS10	18 dBm	-63 dBm
	MCS11	18 dBm	-61 dBm
802.11n (HT40)	MCS0	23 dBm	-89 dBm
	MCS1	23 dBm	
	MCS2	23 dBm	
	MCS3	22 dBm	
	MCS4	22 dBm	
	MCS5	21 dBm	
	MCS6	21 dBm	
	MCS7	20 dBm	-69 dBm
802.11ac (VHT40)	MCS8	19 dBm	-65 dBm
	MCS9	19 dBm	-63 dBm
802.11ax (HE40)	MCS10	18 dBm	-60 dBm
	MCS11	18 dBm	-58 dBm

RADIO 2,5 GHz:

RF PERFORMANCE TABLE

Operating Mode	Data Rate	TX Power	RX Sensitivity
802.11a	6 Mbps	23 dBm	-89 dBm
	9 Mbps	23 dBm	
	12 Mbps	22 dBm	
	18 Mbps	22 dBm	
	24 Mbps	21 dBm	
	36 Mbps	21 dBm	
	48 Mbps	20 dBm	
	54 Mbps	19 dBm	-70 dBm
802.11n (HT20)	MCS0	23 dBm	-89 dBm
	MCS1	23 dBm	
	MCS2	22 dBm	
	MCS3	22 dBm	
	MCS4	21 dBm	
	MCS5	21 dBm	
	MCS6	20 dBm	
	MCS7	19 dBm	-70 dBm
802.11ac (VHT20)	MCS8	18 dBm	-67 dBm
	MCS9	18 dBm	-65 dBm
802.11ax (HE20)	MCS10	17 dBm	-62 dBm
	MCS11	16 dBm	-60 dBm
802.11n (HT40)	MCS0	23 dBm	-86 dBm
	MCS1	23 dBm	
	MCS2	22 dBm	
	MCS3	22 dBm	
	MCS4	21 dBm	
	MCS5	21 dBm	
	MCS6	20 dBm	
	MCS7	19 dBm	-67 dBm
802.11ac (VHT40)	MCS8	18 dBm	-64 dBm
	MCS9	18 dBm	-62 dBm
802.11ax (HE40)	MCS10	17 dBm	-59 dBm
	MCS11	16 dBm	-57 dBm
802.11ac (VHT80)	MCS0	23 dBm	-83 dBm
	MCS1	23 dBm	
	MCS2	22 dBm	
	MCS3	22 dBm	
	MCS4	21 dBm	
	MCS5	21 dBm	
	MCS6	20 dBm	
	MCS7	19 dBm	
	MCS8	18 dBm	
	MCS9	18 dBm	-59 dBm
802.11ax (HE80)	MCS10	17 dBm	-56 dBm
	MCS11	16 dBm	-54 dBm

RADIATION PATTERNS

RADIO 1, 2.4 GHz:

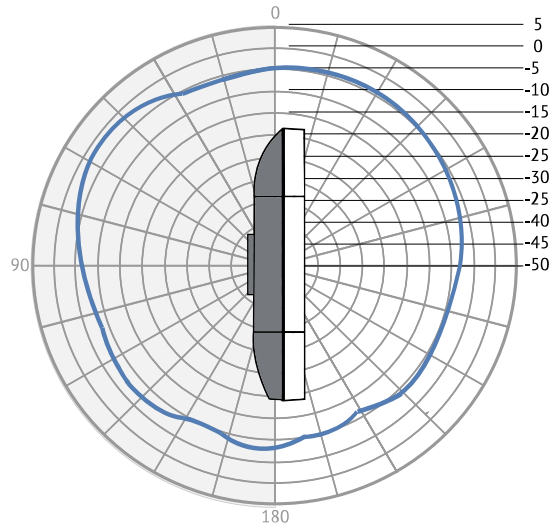
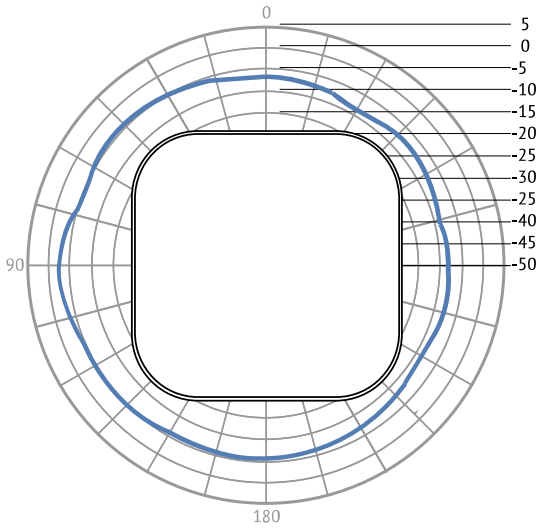

RADIO 2, 5 GHz:

